

SAGINAW CONTROL & ENGINEERING SCE-3PBAI

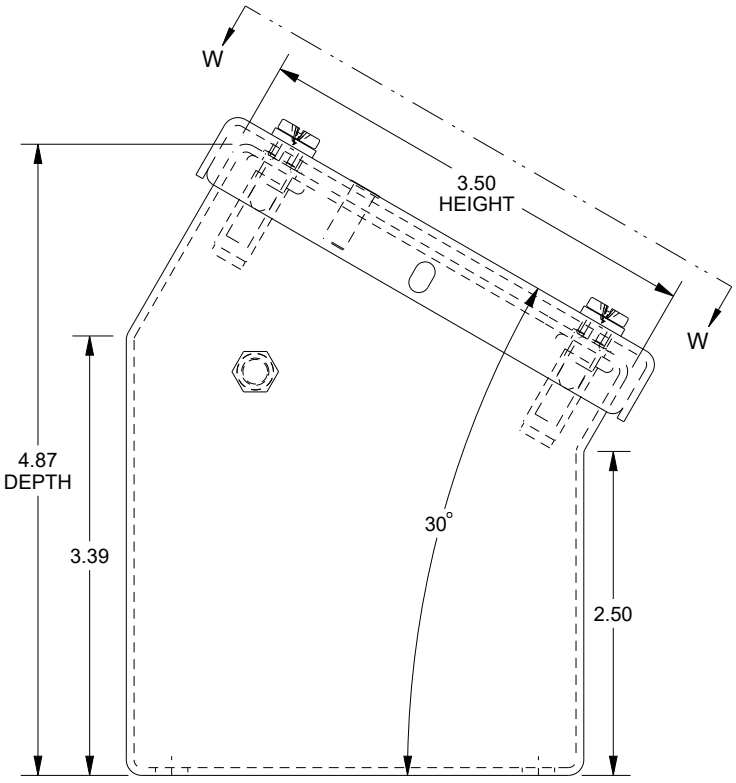

REAR VIEW



LEFT SIDE VIEW

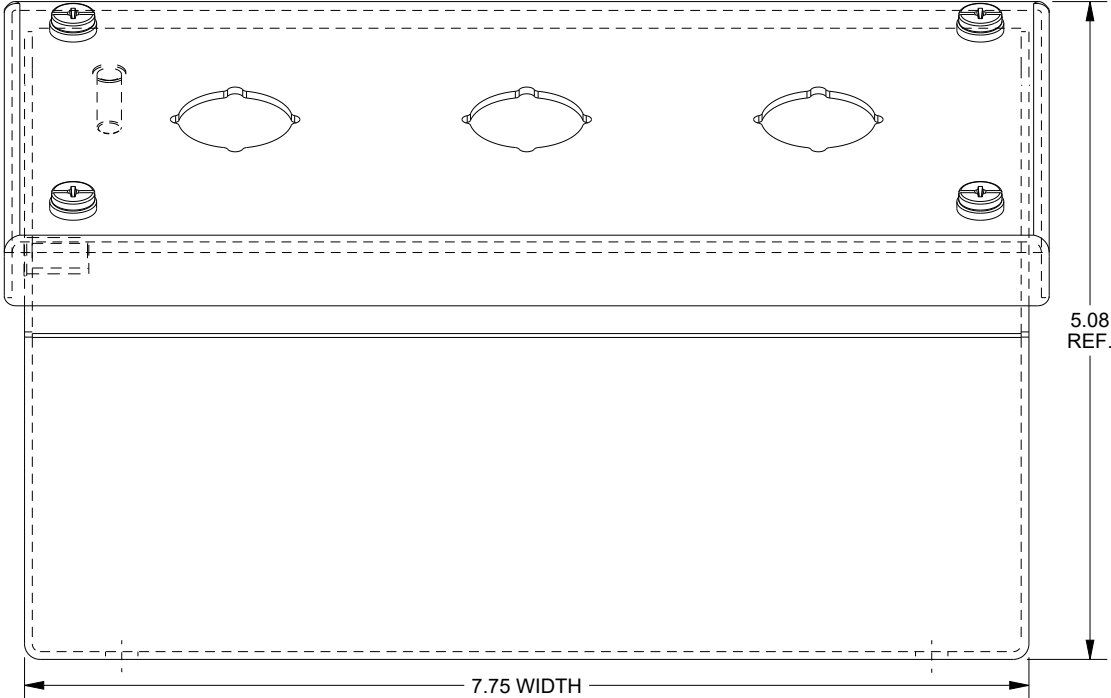

FRONT VIEW

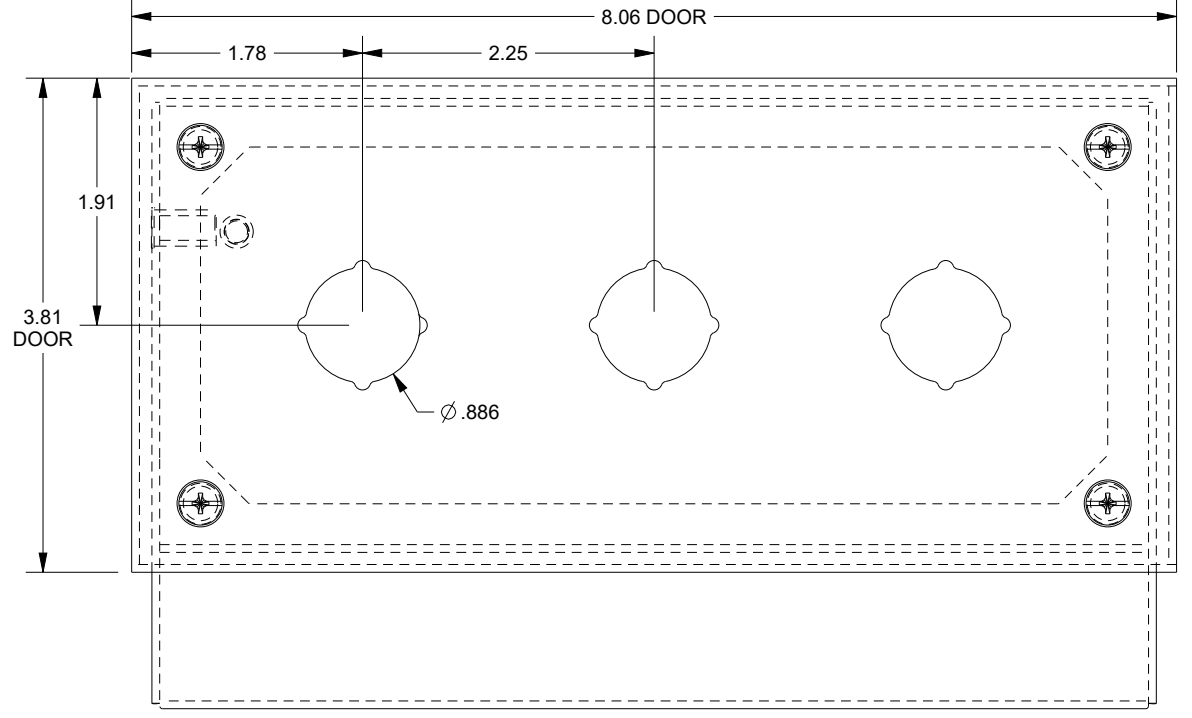

SECTION W-W

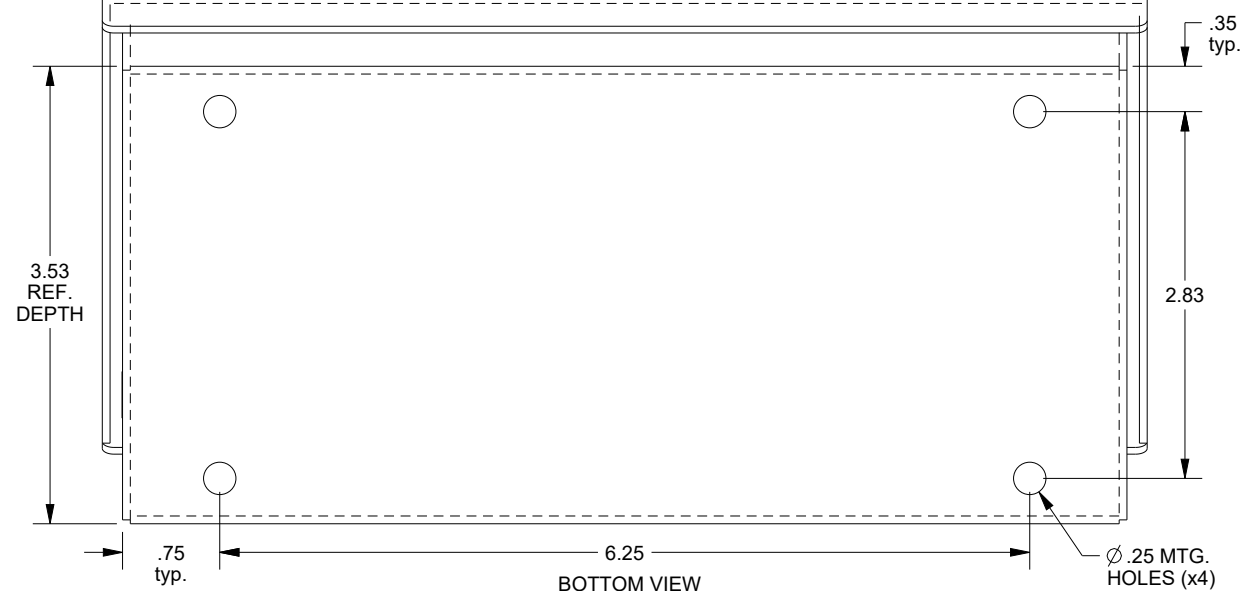

BOTTOM VIEW